

Article number: 0128047

Description: Circlip RW 30 DIN 7993

## Measures

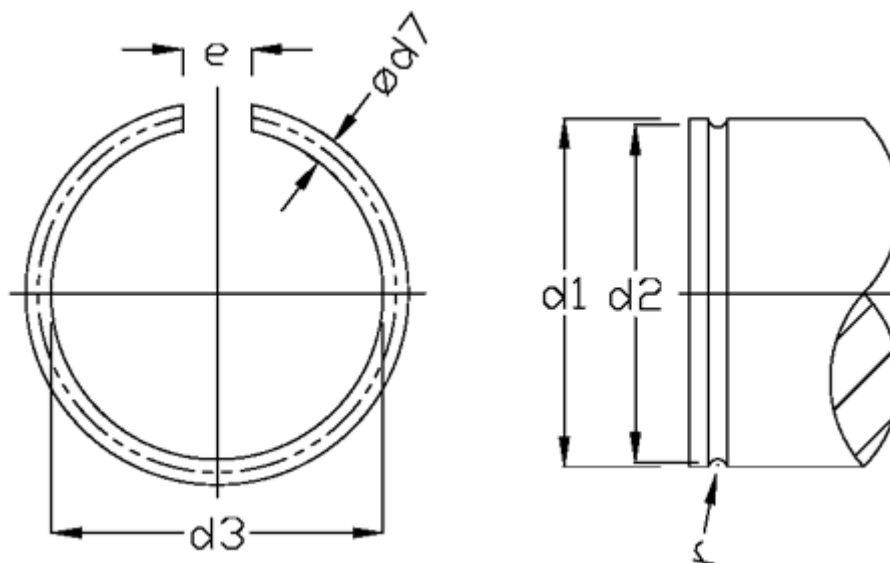

d1	= 30	tol	= 0.10
d2	= 28.0	tol	= -0.5
d3	= 27.7	Weight kg/1000 = 2.220	
d7	= 2.0		
Description	= RW 30		
e	= 3		
n abl x 1000	= 8		
r	= 1.1		